

Success is in the details.

AutoCAD®

Structural Detailing



Autodesk®

Extend Design to Fabrication

Better precision and greater productivity for detailing and creation of fabrication shop drawings.

We have been using AutoCAD Structural Detailing software and its previous versions for our structural steel drawings since 2003. The bidirectional link with Autodesk Robot Structural Analysis Professional provides a flexible workflow that allows us to create fabrication and erection drawings directly from the analysis model or to analyze a model initially created in AutoCAD Structural Detailing.

—Christophe Tremoulet
Principal
Ingetech, France

AutoCAD Structural Detailing software, built on the familiar AutoCAD® platform, helps structural engineers, detailers, and fabricators to create more precise detailing and fabrication shop drawings. AutoCAD Structural Detailing helps improve design accuracy by providing tools that automate the generation of more complete and comprehensive details, drawings, schedules, and material takeoffs. The software provides tools that help automate the creation of concrete reinforcement drawings and enable efficient modeling of steel connections and shop drawings. AutoCAD Structural Detailing supports the BIM process for structural engineering by extending structural design workflows to fabrication, enabling a more efficient and accurate process for creating fabrication details and drawings.

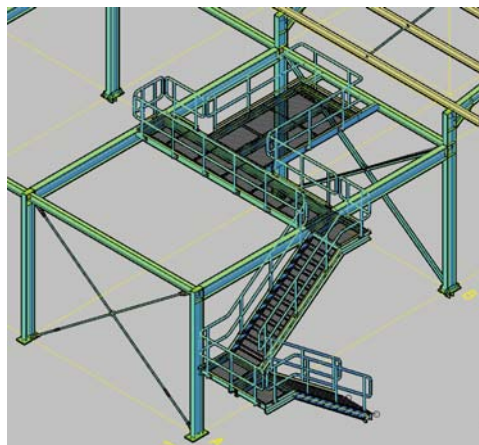

Collaboration with Autodesk Revit Structure

With direct links between AutoCAD Structural Detailing and Autodesk® Revit® Structure software, structural information within the building information model (BIM) can be extended from design directly to fabrication. Using Revit® Extensions for Autodesk® Revit® Structure software, an exclusive Subscription benefit for Revit Structure, subscribers can export concrete reinforcement data from Autodesk Revit Structure and generate 2D reinforcement drawings in AutoCAD Structural Detailing based on a selected national code. A bidirectional link with Autodesk® Revit® Structure software enables a structural steel model to be sent directly to AutoCAD Structural Detailing. This connection helps make it possible to complete all of the steel connection modeling and detailing, which can be used to automatically create fabrication shop drawings.

Interoperability with Structural Analysis Software

AutoCAD Structural Detailing enables the import of structural steel models created in Autodesk® Robot™ Structural Analysis software or CIS/2 files for faster 3D assembly and further detailing. The reinforcement detailing capabilities of AutoCAD Structural Detailing enables users to import reinforcement data from Autodesk Robot Structural Analysis for automatic generation of drawings.

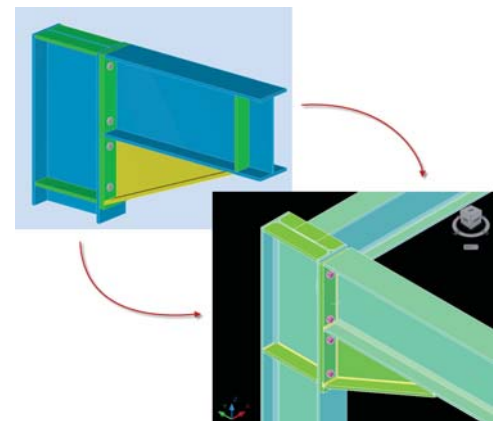

Links to CNC Machines for Fabrication

AutoCAD Structural Detailing provides direct links to computer numeric controlled (CNC) fabrication machines through DSTV format, helping to minimize redundant data input for the fabrication of steel parts.

Country-Specific Detailing Templates

Creating shop drawing documentation strongly depends on regional codes and detailing methods characteristic for each country (especially for RC drawings). For that reason, AutoCAD Structural Detailing offers templates that are based on detailing practices, such as designations and hatching patterns, from a multitude of countries, helping to guide you according to local detailing methods and appropriate elements or material schedules.

Regional Databases

AutoCAD Structural Detailing includes multiple databases from many countries around the world to help provide access to locally required elements (steel sections, materials, or rebar shapes).

Powerful and Comprehensive Steel Modeling and Detailing

AutoCAD Structural Detailing software enables the creation of precise structural steel models and shop drawings.

An integrated solution, the steel detailing capabilities of AutoCAD Structural Detailing software provide comprehensive and powerful drafting tools for commercial and industrial steel building projects.

Structure Definition

Create your model in a 3D environment from the provided database library or define your own steel shapes with AutoCAD Structural Detailing. Convert any line from AutoCAD software into a viable steel section, and precisely situate structural elements using the 3D work frame. Define structural parts and assign connections. In addition, convey and present realistic complexities of your design with a comprehensive 3D structural model.

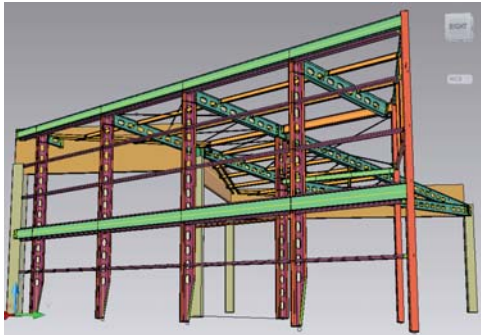

Intelligent Objects

Help simplify your modeling processes using profiles, plates, and other objects. Virtually cut, lengthen, bend, split, and merge while updating material takeoffs.

Powerful Modeling and Connection Detailing Macros

AutoCAD Structural Detailing provides special tools and smart macros that help speed automation of time-consuming structural tasks, including connections, roof trusses, stairs, railings, ladders, and automatically spread elements, such as grates or purlins.

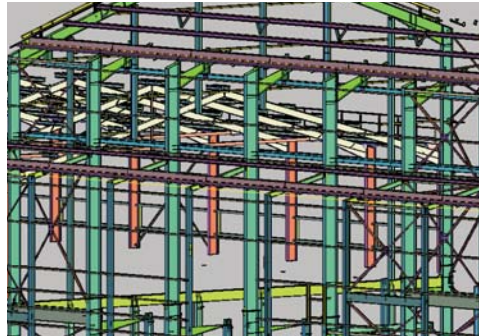
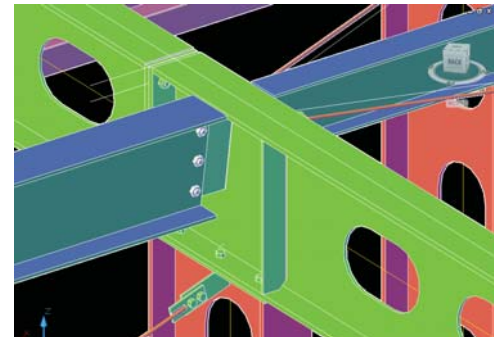

Photo and model courtesy of Christophe Tremoulet, Ingetech.

Customizable Detailing and Shop-Drawings Styles

Styles enable users to adjust the look of final shop drawings. It is possible to change many drawing elements, descriptions, symbols, dimensions, or tables. Create new styles or modify existing ones to help make your drawings look the way you want.



Drawings and Material Takeoff Generation

Use your 3D structural model to automatically generate workshop drawings, schedules, and material takeoff data. Intuitively change your model, and leave time-consuming documentation updates to AutoCAD Structural Detailing.

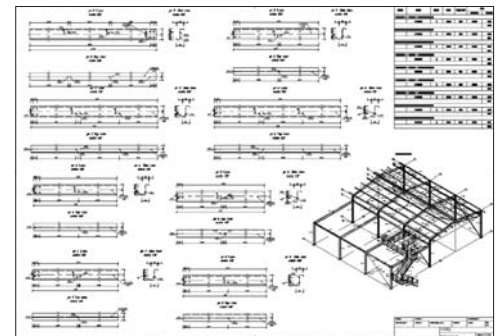

Faster and More Efficient Reinforcement Detailing and Scheduling

Automate reinforcement definition and generate shop drawings for all types of structural concrete members.

AutoCAD Structural Detailing software offers reinforcement detailing capabilities and provides templates that are based on detailing practices in a number of countries, enabling better adherence to local detailing methods and appropriate bar schedules. Execute faster and more efficient detailing and scheduling of concrete elements, including pad footings, staircases, beams, and columns, using intelligent tools and macros.

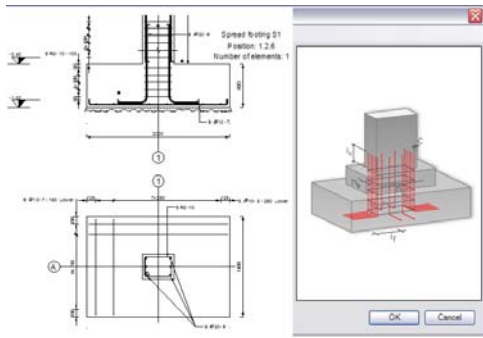

Rebar Definition

Use standard shape bars based on a wide variety of country codes, or draw your own nonstandard bar shapes. Define longitudinal reinforcement and rebar in cross section, and enjoy automatic, more appropriate distribution. Choose from a variety of reinforcement types, including straight bars, radial reinforcement, or wire fabric.

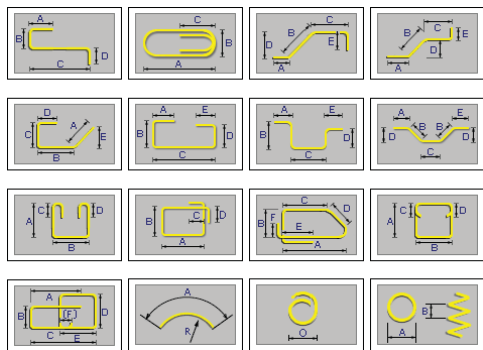

Intelligent Rebar Elements

Define reinforcement of structure members using objects and bars, with automatic accounting for covers and hooks.

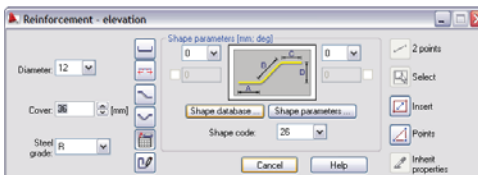
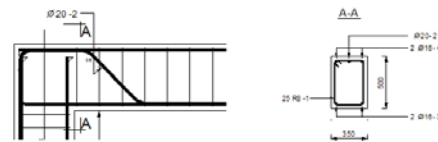

Concrete Element and Rebar Definition Macros

Generate comprehensive concrete reinforcement drawings, together with rebar descriptions and material takeoffs, with AutoCAD Structural Detailing macros.

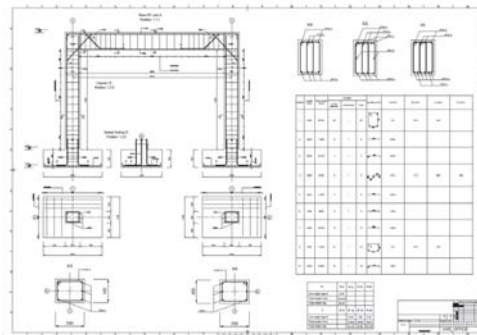

Drawing Preparation and Material Takeoffs Generation

Help speed up preparation of your reinforcement drawings with tools to automate rebar definition. Automatically produce schedules within AutoCAD Structural Detailing, or export to Microsoft® Excel® software or Microsoft® Word software. Automatically update schedules to reflect changes in your drawings, as you make them.

Our engineering group uses AutoCAD Structural Detailing to produce reinforcement shop drawings specifically for concrete shear walls. In order to automate the distribution, tagging, and scheduling necessary for our specific rebar drawings, we were able to develop custom tools based on existing macros. Beyond the productivity gains, AutoCAD Structural Detailing provides ease of use and programming capabilities for our engineering teams.

—Sébastien Scholl
IT Project Manager
Spie Fondations, France

Building Information Modeling for Structural Engineering

Integrated tools for modeling, coordination, analysis, design documentation as well as shop drawings and fabrication.

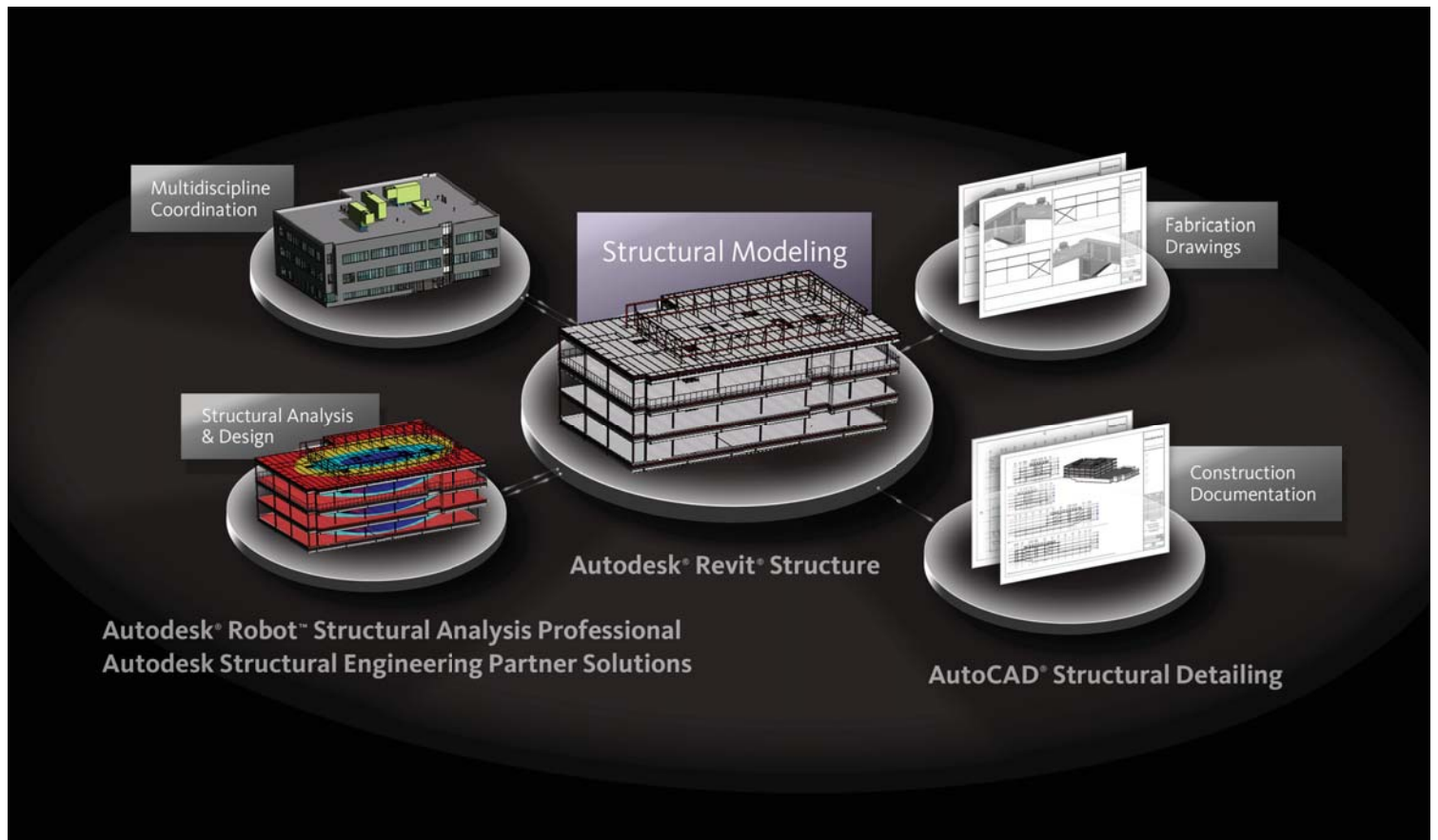

Building information modeling (BIM) is an integrated process built on coordinated, reliable information about a project from design through construction and into operations. By adopting BIM, architects, engineers, contractors, and owners can more easily create coordinated, digital design information and documentation; use that information to visualize, simulate, and analyze performance, appearance, and cost; and reliably deliver the project faster, more economically, and with reduced environmental impact.

BIM for structural engineers follows this same methodology for the entire structural engineering process, focusing on a digital model that can be used for coordination with architects; mechanical, electrical, and plumbing engineers; and civil engineers that is integrated with analysis, design, and construction documentation, and extending that digital model from design through fabrication and construction.

AutoCAD Structural Detailing supports the BIM process for structural engineering by extending structural design workflows to fabrication, enabling a more efficient and accurate process for creating fabrication details and drawings.

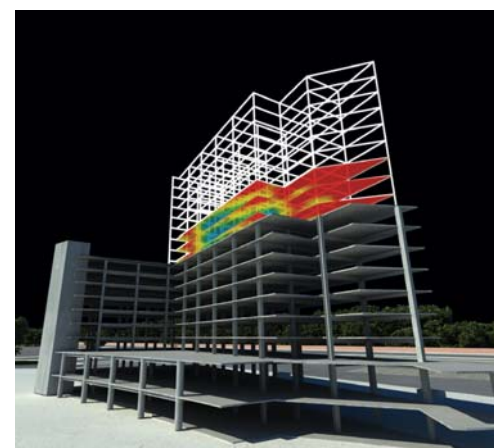

AutoCAD Structural Detailing is an intuitive and user-friendly tool for creating shop drawings. One of its biggest advantages is the ability to customize styles according to our requirements, and its work environment gives us the flexibility we need on our projects.

—Adam Zieba
Managing Director
Bartels Poland

Learn More or Purchase

Access specialists worldwide who can provide product expertise, a deep understanding of your industry, and value that extends beyond your software. To license AutoCAD Structural Detailing software, contact an Autodesk Premier Solutions Provider or Autodesk Authorized Reseller. Locate a reseller near you at www.autodesk.com/reseller.

Autodesk Learning and Education

From instructor-led or self-paced classes to online training or education resources, Autodesk offers learning solutions to fit your needs. Get expert guidance at an Autodesk Authorized Training Center (ATC®) site, access learning tools online or at your local bookstore, and validate your experience with Autodesk certifications. Learn more at www.autodesk.com/learning.

Autodesk Services and Support

Help accelerate return on investment and optimize productivity with companion products, consulting services, and support from Autodesk and Autodesk authorized partners. Designed to get you up to speed and keep you ahead of the competition, these tools help you make the most of your software—no matter what industry you are in. Learn more at www.autodesk.com/servicesandsupport.

Autodesk Subscription

Autodesk® Subscription gives you immediate access to software upgrades and exclusive access to service and support benefits designed to help you get the most out of your Autodesk software. Learn more at www.autodesk.com/subscription.

This brochure is printed on 100 percent postconsumer waste recycled paper.

Autodesk, AutoCAD, ATC, Revit, and Robot are registered trademarks or trademarks of Autodesk, Inc., and/or its subsidiaries and/or affiliates in the USA and/or other countries. All other brand names, product names, or trademarks belong to their respective holders. Autodesk reserves the right to alter product and services offerings, and specifications and pricing at any time without notice, and is not responsible for typographical or graphical errors that may appear in this document.
© 2010 Autodesk, Inc. All rights reserved. 587B1-000000-MZ01